



WINCHESTER

Hamilton Home Products, Inc.

(800) 879-0123



DELUXE HIGH EFFICIENCY UPFLOW CONDENSING GAS FIRED FURNACES WUN SERIES

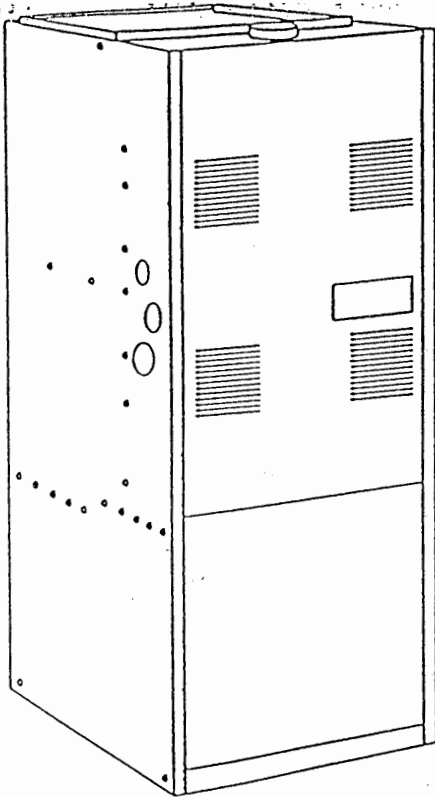

MODEL PBNU - STYLE D
40-140 MBH INPUT



DESCRIPTION

These Category M, highly efficient, compact, sealed combustion, condensing type furnaces are designed for residential and commercial installations in a basement, closet, alcove, recreation room or garage where the ambient temperature is above 32°F, or higher. All use outdoor combustion air. They may be either side wall or thru-roof vented using approved plastic type combustion air and vent piping. A Vent Termination Kit is required. All units are factory assembled, wired and tested to assure dependable and economical installation and operation.

FEATURES

- Electronic hot surface ignition saves fuel cost with increased dependability and reliability.
- Induced combustion system with Inshot main burners for quiet, efficient operation with low NOx emissions of 35 nanograms/joule.
- 100% shut off main gas valve for extra safety. Propane model convertible to natural gas.
- PSC - multiple speed, direct drive motor with large, quiet blower.
- 24V, 40 VA control transformer and cooling relay supplied for add-on cooling.
- Hi-tech sectionalized primary heat exchanger of aluminized steel.
- Streamlined secondary (condensing) heat exchanger of high-grade stainless steel.
- Lifetime limited warranty on both heat exchangers to the original purchaser; a 10-year limited warranty from original installation date to subsequent purchaser. 5-year warranty on commercial applications.
- Uses outdoor combustion air to reduce internal heat load and drafts along with reduced potential for corrosion caused by contaminated indoor combustion air.
- Timed on, adjustable off blower capability.
- Blower door safety switch and combustion air safety.
- Solid (knock out) bottom to assure rattle free operation.
- Attractively styled with baked-enamel finish.
- Easy access from front of unit for cleaning, maintenance or service.
- Cleanable, high efficiency filters supplied with furnaces.

INSTALLATION INSTRUCTION

GAS-FIRED FURNACES HIGH-EFFICIENCY UPFLOW CONDENSING MODELS

Supersedes: 650.65-N2W (1191)

650.65-N2W (1294)

035-10976

MODELS: WUN SERIES

ELUXE HIGH EFFICIENCY
UPFLOW CONDENSING
GAS FIRED FURNACES

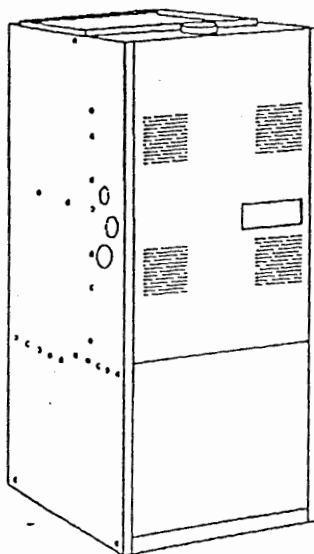

UPFLOW MODELS
TYPE FSP
DIRECT VENT FURNACE

FOR YOUR SAFETY

WHAT TO DO IF YOU SMELL GAS

- Do not try to light any appliance.
- Open windows.
- Do not touch any electrical switch; do not use any phone in your building.
- Extinguish any open flames.
- Immediately call your gas supplier from a neighbor's phone. Follow the gas supplier's instructions.
- If you cannot reach your gas supplier, call the fire department.

FOR YOUR SAFETY

Do not store or use gasoline or other flammable vapors and liquids in the vicinity of this or any other appliance.

WARNING: Improper installation, adjustment, alteration, service or maintenance can cause injury or property damage. Refer to this manual. For assistance or additional information, consult a qualified installer, service agency or the gas supplier.

TABLE OF CONTENTS

GENERAL INFORMATION	
Description	2
Inspection	2
Notes, Cautions, & Warnings	2
Limitations & Location	3 & 5
SPECIFIC UNIT INFORMATION	
Clearance	3
Nomenclature	3
Dimensions	4
Ratings & Physical Data	4
Combustion Air & Vent System	5
Unit Wiring Diagrams	16-17
UNIT INSTALLATION	
Ductwork	5-6
Filters	6
Combustion Air/Vent Sizing	6
Combustion Air Intake	7
Vent Pipe Connections	7
Piping Assembly	7
Vent Terminal Assembly	8
Gas Piping	8-9
Condensate Piping	9
Electrical Data	9
Electrical Connections	9-10
Safety Controls	10
Start-Up & Adjustments	10-11
Ignition System Checkout/Adjustment	11
Adjustment of Manifold Gas Pressure	11
Adjustment of Primary Air	11-12
Checking Gas Input	12
Adjustment of Temperature Rise	12
Adjustment of Fan Control Settings	12
Checking Limit Control	12
OPERATION & MAINTENANCE	
Sequence of Operation	13
50E47 Ignition Control	13
Maintenance	13
Air Filters	13
Blowers	14
Burners	13-14
Lubrication	13
Primary Heat Exchanger	14
Secondary Heat Exchanger	14
Troubleshooting	18

GENERAL INFORMATION

DESCRIPTION

This Category IV, 135 °F maximum vent temperature, sealed combustion furnace is designed for residential installation in a basement, closet, recreation room or garage, provided space temperature is 32°F or higher. Model PBNU Style C units are available for direct installation using natural gas (N) or propane (P). Ensure the proper model is installed for the available fuel gas.

Model PBNU (P) units may be converted to natural gas if factory supplied components are used. High altitude conversions required in order for the appliance to satisfactorily meet the application must be made by a UPG distributor, conversion station or other qualified agency, using factory specified and/or approved parts.

INSPECTION

As soon as a unit is received, it should be inspected for possible damage during transit. If damage is evident, the extent of the damage should be noted on the carrier's freight bill. A separate request for inspection by the carrier's agent should be made in writing. Also, before installation the unit should be checked for screws or bolts which may have loosened in transit. There are no shipping or spacer brackets which need to be removed.

NOTES, CAUTIONS, & WARNINGS

The installer should pay particular attention to the words:

NOTE, CAUTION and WARNING. **NOTES** are intended to clarify or make the installation easier. **CAUTIONS** are given to prevent equipment damage. **WARNINGS** are given to alert the installer that personal injury and/or equipment or property damage may occur if installation procedures are not handled properly.

CAUTION: The cooling coil must be installed in the supply air ductwork of the furnace.

The furnace must not be used as a broom closet or for any other storage purposes as a fire hazard may be created. Never store items such as the following on, near, or in contact with the furnace.

1. Spray or aerosol cans, rags, brooms, dust mops, vacuum cleaners or other cleaning tools.
2. Soap powders, bleaches, waxes or other cleaning compounds; plastic items or containers; gasoline, kerosene, cigarette lighter fluid; dry-cleaning fluids or other volatile fluid.
3. Paint thinners and other painting compounds.
4. Paper bags or other paper products.

WARNING: Never operate the furnace with the blower door removed. To do so could result in serious personal injury and/or equipment damage.

WARNING: This furnace may not be common vented with any other appliance, since it requires separate, properly-sized air intake and vent lines. The furnace shall not be connected to any type of B, BW or L vent or vent connector, and not connected to any portion of a factory-built or masonry chimney.

If this furnace is replacing a common-vented furnace, it may be necessary to resize the existing vent line and chimney to prevent oversizing problems for the new combination of units. Refer to the National Gas Code (ANSI Z223.1-) or CAN1-B149.1 or .2 Installation Code (latest editions).

The following steps shall be followed with each appliance connected to the venting system placed in operation, while any other appliances connected to the common venting system are not in operation:

1. Seal any unused openings in the venting system;

2. Inspect the venting system for proper size and horizontal pitch, as required in the National Fuel Gas Code, ANSI Z223.1 or the CAN/CGA B149 Installation Codes and these instructions. Determine that there is no blockage or restriction, leakage, corrosion or other deficiencies which could cause an unsafe condition;
3. In so far as is practical, close all building doors and windows and all doors between the space in which the appliance (s) connected to the venting system are located and other spaces of the building. Turn on clothes dryers and any appliance not connected to the venting system. Turn on any exhaust fans, such as range hoods and bathroom exhausts, so they will operate at maximum speed. Do not operate a summer exhaust fan. Close fireplace dampers;
4. Follow the lighting instructions. Place the appliance being inspected in operation. Adjust the thermostat so appliance shall operate continuously;
5. Test for draft hood equipped appliance spillage at the draft hood relief opening after 5 minutes of main burner operation. Use the flame of a match or candle;
6. After it has been determined that each appliance connected to the venting system properly vents when tested as outlined above, return doors, windows, exhaust fans, fireplace dampers and any other gas burning appliance to their previous conditions of use;
7. If improper venting is observed during any of the above tests, the venting system must be corrected;
8. Any corrections to the common venting system must be in accordance with the appropriate tables in Appendix G of the National Fuel Gas Code Z223.1 and/or CAN/CGA-B149 Installation Codes. If the common vent system must be resized, it should be resized to approach the minimum size as determined using the appropriate tables of the above codes. An improperly sized venting system could result in the formation of condensate and leakage or spillage of combustion products.

LIMITATIONS & LOCATION

This furnace should be installed in accordance with all national and local building/safety codes and requirements, or in the absence of local codes, with the National Fuel Gas Code ANSI Z223.1 or CAN/CGA-B149 Installation Codes (latest editions), local plumbing or waste water codes, and other applicable codes.

CAUTION: Do not install the furnace in an unconditioned space or garage that could experience ambient temperatures of 32° F (0° C) or lower.

CAUTION: This unit must be installed in a level (1/4") position side-to-side and front-to-back to provide proper condensate drainage.

CAUTION: Do not allow return air temperature to be below 55 °F for extended periods. To do so may cause condensate to occur in the main fired heat exchanger.

WARNING: Furnaces shall not be installed directly on carpeting, tile or other combustible material other than wood flooring.

WARNING: Furnace shall be installed so the electrical components are protected from water.

WARNING: This appliance is not to be used for temporary heating of buildings or structures under construction.

The size of the unit should be based on an acceptable heat loss calculation for the structure.

Check the rating plate to make certain the unit is equipped for the type of gas supplied, and proper electrical characteristics are available.

For installations above 2,000 feet, reduce input 4% for each 1,000 feet above sea level. In Canada, derate input 10% for elevations at 2,000-4,500 feet.

WARNING: Do not install this unit in a mobile home.

A furnace installed in a residential garage shall be located so that all burners and burner ignition devices are located not less than 18" above the garage floor, and located or protected to prevent damage by vehicles.

SPECIFIC UNIT INFORMATION

CLEARANCES TO COMBUSTIBLES

Minimum clearances from combustible construction are in inches:

Top.....	1
Front	3
Vent Piping	0
Rear	0
Sides	0

CLEARANCES FOR ACCESS

Ample clearances should be provided to permit easy access to the unit. The following minimum clearances are recommended:

1. Twenty-four (24) inches between the front of the furnace and an adjacent wall or another appliance, when access is required for servicing and cleaning.
2. Eighteen (18) inches at the side where access is required for passage to the front when servicing or for inspection or replacement of flue/vent connections.

NOTE: In all cases, accessibility clearances shall take precedence over clearances for combustible materials where accessibility clearances are greater.

NOMENCLATURE

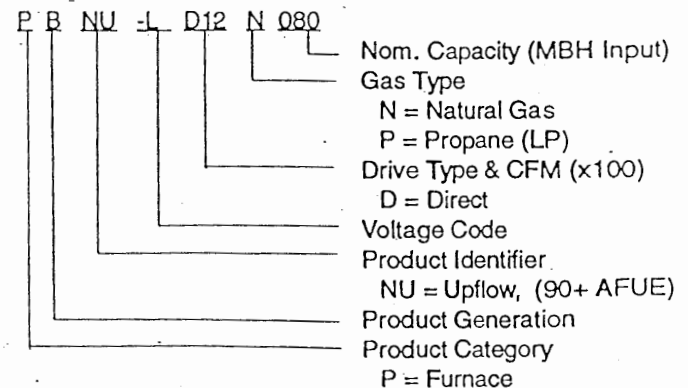

DIMENSIONS

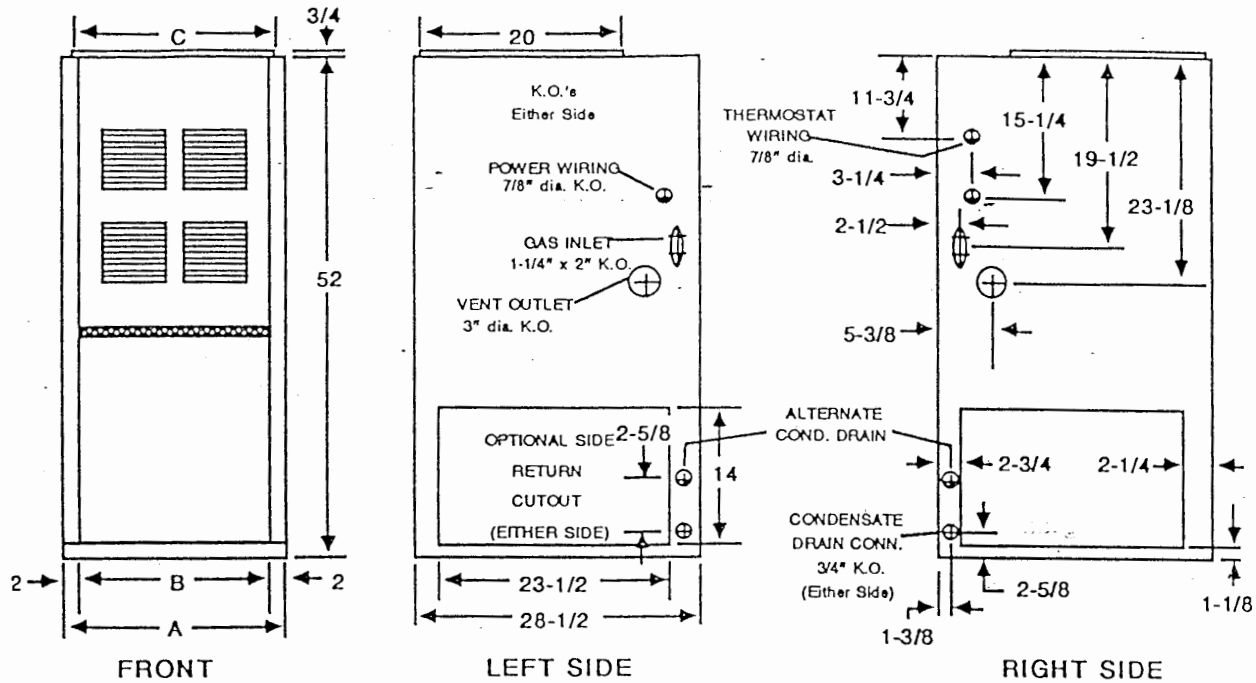

All dimensions are in inches, and are approximate. Certified dimensions are available upon request.

MODEL	A	B	C	D
PBNU-LD06P040/PBNU-LD06N040	12-1/4	8	11	2
PBNU-LD10P060/PBNU-LD10N060	16-1/4	12	15	2
PBNU-LD12P080/PBNU-LD12N080	16-1/4	12	15	2
PBNU-LD16P080/PBNU-LD16N080	22-1/4	18	21	2
PBNU-LD12P100/PBNU-LD12N100	22-1/4	18	21	3
PBNU-LD20P100/PBNU-LD20N100	22-1/4	18	21	3
PBNU-LD16P120/PBNU-LD16N120	22-1/4	18	21	3
PBNU-LD20P140/PBNU-LD20N140	26-1/4	22	25	3

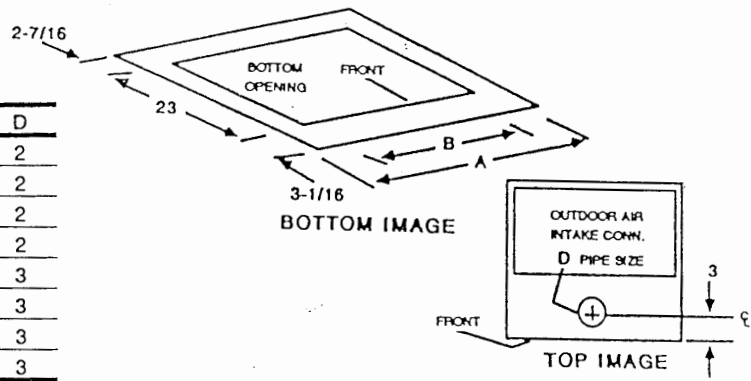

TABLE 1 - RATINGS & PHYSICAL DATA

Model	Air Temp. Rise °F	Max. Outlet Temp. °F	Blower		Filter Size		Unit Full Load Amps	Max. Over-Current Protect.	Min. Wire Size (AWG) @ 75 ft. One Way
			HP	Size	Supplied	Suggested Bottom			
PBNU-LD06P040/PBNU-LD06N040	45-75	175	1/5	9-4	16x26 Side	12x26	- 5.1	15	14
PBNU-LD10P060/PBNU-LD10N060	45-75	175	1/3	10-6	16x26 Side	16x26	7.7	15	14
PBNU-LD12P080/PBNU-LD12N080	45-75	175	1/2	11-8	16x26 Side	16x26	9.1	15	14
PBNU-LD16P080/PBNU-LD16N080	45-75	175	1	11-10	16x26 Side	20x26	15.5	20	12
PBNU-LD12P100/PBNU-LD12N100	55-85	185	1/3	10-8	20x26 Btm See Note 3	20x26	8.0	15	14
PBNU-LD20P100/PBNU-LD20N100	55-85	185	1	11-10	20x26 Btm See Note 3	20x26	15.5	20	12
*PBNU-LD16P120/PBNU-LD16N120	50-80	180	1/2	10-10	20x26 Btm See Note 3	20x26	11.6	15	14
PBNU-LD20P140/PBNU-LD20N140	55-85	185	1	11-10	24x26 Btm 16x26 Side	24x26	-15.5	20	12

* For side return applications, these models require either both side inlets or bottom and one side.
 NOTES: 1. All furnaces are factory wired for 115-1-60 operation.
 2. All Filters supplied with the furnace are high-velocity, cleanable type.
 3. Recommended filter size for side return is 16x26.

Allow clearances from combustible materials as listed under "Clearances to Combustibles", ensuring that service access is allowed for both the burners and blower.

When the furnace is used in conjunction with a cooling coil, the furnace must be installed parallel with or on the upstream side of the cooling unit to avoid condensation in the primary heat exchanger. When a parallel flow arrangement is used, the dampers or other means used to control air flow shall be adequate to prevent chilled air from entering the furnace, and if manually operated, must be equipped with means to prevent operation of either unit unless the damper is in the full heat or cool position.

The furnace shall be located:

1. Where a minimum amount of air intake/vent piping and elbows will be required.
2. As centralized with the air distribution as possible.
3. In an area where ventilation facilities provide for safe limits of ambient temperature under normal operating conditions. Ambient temperatures must not fall below 32°F (0° C).
4. Where it will not interfere with proper air circulation in the confined space.
5. Where the outdoor combustion air/vent terminal will not be blocked or restricted.
6. Where it will not interfere with the cleaning, servicing or removal of other appliances.

COMBUSTION AIR AND VENT SYSTEM

This furnace requires outdoor combustion air. Two separate, properly-sized pipes must be used; one bringing outdoor air from the accessory terminal kit outdoors to the furnace combustion air intake (top of unit), and one from the furnace vent connection (left or right side of unit) back to the terminal kit located outdoors.

The vent terminal kit should be located either through the wall (horizontal or side vent) or through the roof (vertical vent). Care should be taken to locate side vented systems where trees or shrubs will not block or restrict supply air from entering or combustion products from leaving the terminal. Also, the terminal assembly should be located as far as possible from a swimming pool or a location where swimming pool chemicals might be stored. Be sure the terminal assembly follows the outdoor clearances listed in the following table for U.S. installations: In Canada, refer to CAN/CGA-B149.1 or .2 Installation Code (latest edition -Venting Systems and Air supply).

VENT TERMINATION (U.S. ONLY)

Dryer Vent	4 feet
Plumbing Vent Stack	3 feet
Gas Appliance Vent Terminal	1 foot
From any opening where vent gas could enter the building	
Above grade and anticipated snow depth	1 foot
Above grade when adjacent to a public walkway	7 feet
From electric, gas meters, regulators and relief equipment - min. horizontal distance	4 feet

NOTE: Consideration must be given for degradation of building materials by flue gases.

For proper vent/combustion air intake sizing and installation, see the section of this instruction "Combustion Air/Vent Pipe Sizing."

UNIT INSTALLATION

DUCTWORK

The duct system's design and installation must:

1. Handle an air volume appropriate for the served space and within the operating parameters of the furnace specifications.
2. Be installed in accordance with standards of NFPA (National Fire Protection Association) as outlined in NFPA pamphlets 90A and 90B or applicable national, provincial, local fire and safety codes.
3. Create a closed duct system. The supply duct system must be connected to the furnace outlet and the return duct system must be sealed to the furnace inlet casing. Both supply and return duct systems must terminate outside the space containing the furnace.
4. Generally complete a path for heated or cooled air to circulate through the air conditioning and heating equipment and to and from the conditioned space.

NOTE: The supply air temperature differential between the side discharge versus front to back discharge is substantial. It is recommended that whenever possible position the furnace so left and right side supply air is dominate.

After the unit is in the desired position, fasten the supply ductwork to the furnace duct flanges. A removable access panel should be provided in the outlet duct such that smoke or reflected light would be observable inside the casing to indicate the presence of leaks in the heat exchanger. This access cover shall be attached in such a manner as to prevent leaks. Flexible duct connectors are recommended to connect both the supply and return ducts to the furnace.

Return air ductwork may be connected to an upflow furnace in one of the following two ways:

1. Bottom Return - Before attaching the ductwork to the furnace bottom, see the "Filters" section of this instruction.
2. Side Return - Cut a hole in the side panel of the furnace using the right-angle markings (See Figure 1) as a guide for position and size of the opening. Install a single side return filter frame accessory if one is required. If this accessory is not needed, the ductwork can be fastened directly to the furnace opening.

NOTE: Some accessory side filter packages require cutting a slightly larger opening.

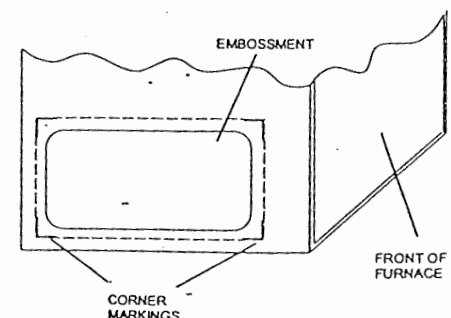

FIGURE 1 - SIDE RETURN CUTOUT MARKINGS

When the return duct system is not complete, the return connection must be run full size from the furnace to a location outside the utility room or basement. For further details, consult Section 5.3, Air Combustion and Ventilation of the National Fuel Gas Code, ANSI Z223.1 or CAN1-B149.1 or .2 Installation Code (latest editions).

FILTERS

The type and size of filter(s) to be used are shown in Table 1.

12-1/4 & 16-1/4 Inch Width Furnaces

All 12-1/4 & 16-1/4 inch wide furnaces are shipped with filters mounted on the left side. Filters may be relocated to the bottom or right side as follows:

The wire filter retainer must be moved if the return air application requires moving of the filter from the side to the bottom location or vice versa. When relocating filters, it may be necessary to trim the filter to the proper size.

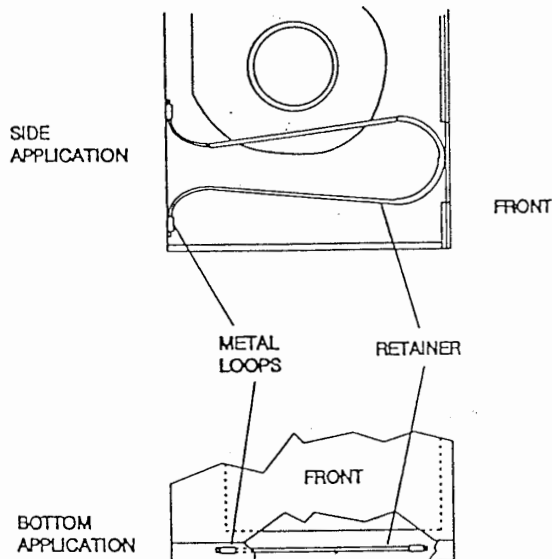

FIGURE 2 -FILTER RETAINER

The ends of the retainer are attached to the rear panel in two metal loops (See Figure 2). The ends must be squeezed together to free them from the loops. The retainer may then be moved to the new location, and the ends inserted in the loops on the rear panel at the new location. Loops are provided for retainer location to accommodate filter application on the bottom or either side of the furnace.

To remove a filter from the bottom location, push the closed end of the filter retainer to the left until it clears the lip on the front of the furnace base, which acts as a catch for the retainer. When the retainer is clear of the lip, lift up. The retainer will pivot in the loops. This will expose the filter to allow removal. To reinstall the filter, simply reverse this procedure.

To remove a filter from the side location, push the closed end of the filter retainer down until it clears the flange on the side panel, which acts as a catch for the retainer. When the retainer is clear of the flange, it will pivot in the loops. Swing the retainer toward the center of the furnace. This will expose the filter to allow removal. To reinstall the filter, simply reverse this procedure.

22-1/4 & 26-1/4 Inch Width Furnaces

22-1/4 & 26-1/4 inch wide furnaces are shipped with filters mounted in the bottom and left side.

For filter removal in these models, follow the same procedure as with the small width furnaces.

COMBUSTION AIR/VENT PIPE SIZING

Refer to Table 2 to select the proper size piping for combustion air intake and venting. The size will be determined by a combination of furnace model, total length of run, and the number of elbows required. The following rules must also be observed.

1. Long radius elbows are recommended for all units except for the 133 MBH unit for which long radius elbows are mandatory.
2. Elbows are assumed to be 90 degrees. Two 45 degree elbows count as one 90 degree elbow.
3. Elbow count refers to combustion air piping and vent piping separately. For example, if the table allows for 5 elbows, this will allow a maximum of 5 elbows in the combustion air piping and a maximum of 5 elbows in the vent piping.
4. The combustion air blower elbow and vent terminal kit parts are already accounted for and should not be counted in the allowable total indicated in the table.
5. Combustion air and vent piping must be of the same diameter.
6. All piping and fittings are to be Schedule 40 PVC, PVC-DWV, ABS-DWV, SDR-21 PVC, or SDR-26 PVC.

COMBUSTION AIR INTAKE

TABLE 2 - COMBUSTION AIR/VENT PIPE SIZES

MODEL	Pipe Size	MAXIMUM ELBOWS PER TOTAL RUN (See Note 2)						
		0-5 feet	5-10 feet	10-15 feet	15-20 feet	20-25 feet	25-30 feet	30-35 feet
PBNU-LD06P040/PBNU-LD06N040	1-1/2" 2"	5 5	4 5	3 5	2 5	Note 1 5	Note 1 5	Note 1 5
PBNU-LD10P060/PBNU-LD10N060	1-1/2" 2"	3 5	2 5	Note 1 5	Note 1 5	Note 1 5	Note 1 5	Note 1 5
PBNU-LD12P080/PBNU-LD12N080	2" 3"	5 5	4 5	3 5	2 5	1 5	Note 1 5	Note 1 5
PBNU-LD16P080/PBNU-LD16N080	2" 3"	5 5	4 5	3 5	2 5	1 5	Note 1 5	Note 1 5
PBNU-LD12P100/PBNU-LD12N100	2"	5	5	5	5	5	5	30' Max
PBNU-LD20P100/PBNU-LD20N100	2"	5	5	5	5	5	5	30' Max
PBNU-LD16P120/PBNU-LD16N120	3"	5	5	5	5	5	5	5
PBNU-LD20P140/PBNU-LD20N140	3"	5	5	5	5	5	5	30' Max.

NOTES: 1. Must use the larger pipe size indicated
2. Long radius elbows recommended on these units, except 140 MBH, when over 25 feet of piping is required. On 140 MBH units, use of long radius elbows is mandatory.

Once the piping size is determined, the combustion air intake collar must be connected to that size piping. Units rated from 40 MBH input (38 MBH output) to 80 MBH input (76 MBH output) are equipped with intake collars which accommodate 2" diameter piping. The 100 MBH input (95 MBH output) through 144 MBH input (133 MBH output) units have collars for 3" diameter piping. When the pipe size listed in the table is different than the size of the intake collar provided with the unit, transition should be made as illustrated in Figure 3.

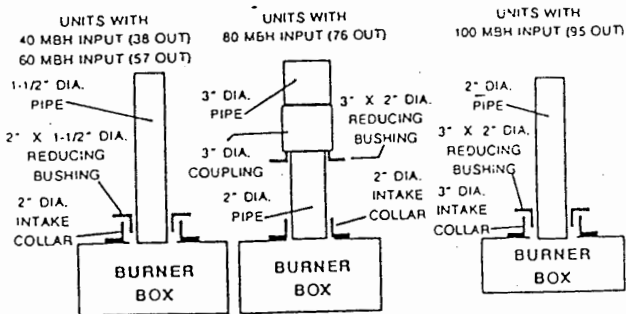

FIGURE 3 - COMBUSTION AIR PIPING ADAPTATION

VENT PIPE CONNECTIONS

All models are provided with a combustion blower elbow which accommodates 2" diameter vent pipe. This elbow may be positioned for right or left exit from the unit as required for the installation conditions.

With reference to the piping sizing table, where units are installed with a vent pipe of a different diameter than the exhaust elbow, reduction or expansion fittings must be incorporated by the installer at the time of installation. Examples of such adaptation are shown in Figure 4.

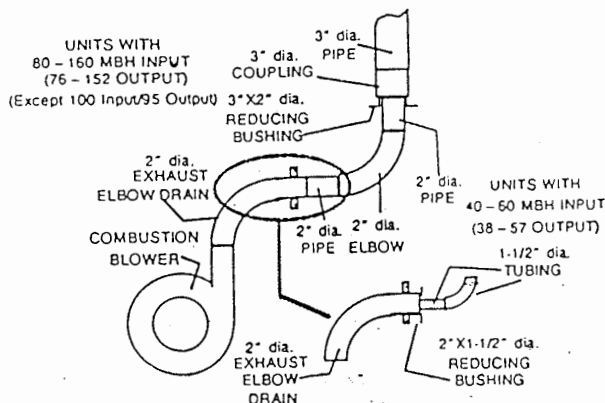

FIGURE 4 - VENT PIPING ADAPTATION

PIPING ASSEMBLY

The final assembly procedure for the vent/combustion air piping is as follows:

1. Cut piping to the proper length, beginning at the furnace.
2. Deburr the piping inside and outside.
3. Chamfer the outer edges of the piping.
4. Dry-fit the entire vent/combustion air piping assembly.
5. Disassemble the piping and apply cement primer and cement per the cement manufacturer's instructions.

Unitary Products Group

Primer and cement must conform to ASTM D2564 for PVC, or ASTM D2235 for ABS piping.

WARNING: Solvent cements are flammable and must be used in well-ventilated areas only. Keep them away from heat sparks and open flames (including pilots). Do not breathe vapors and avoid contact with skin and eyes.

6. All joints must be made to provide a permanent, air-tight water-tight seal. The only exception to this means of joining is where the street elbow is joined to the vent assembly. This joint should be made with RTV sealant. A stainless steel screw should be used in the hole in the venter housing to keep the street elbow in proper alignment. If the street elbow is changed for a left side exit, the stainless steel screw must be reused in the new location. If the elbow/drain is used for right side exit, carefully remove the plastic cap which is factory installed on the lower left drain connection (see Figure 5). Move the drain tubing and clamp from the lower right drain connection to the lower left drain connection. Place the plastic cap on the lower right drain connection.

NOTE: The upper drain connections are not used in upflow installations and are internally sealed.

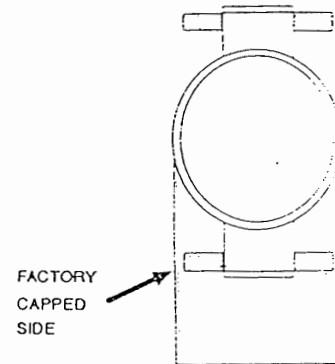

FIGURE 5 - DRAIN CAP LOCATION

Drain tubing from the drain fitting must be routed to prevent kinks and low spots. This tubing may have to be cut and shortened when the flue piping is routed out of the left side of the furnace.

7. Support the combustion air and vent piping such that it is angled 1/4" per linear foot upward from the furnace. Piping should be supported with pipe hangers to prevent sagging. Maximum spacing between hangers is five (5) feet, except SDR-PVC piping, where maximum spacing is three feet.
8. The vent piping must be installed so as to prevent accumulation of condensate and where necessary, hangers must be provided for drainage of condensate.
9. Seal around the openings where the combustion air or vent piping pass through the roof of side wall.

CAUTION: Vent piping must be insulated with 1/2" Armaflex insulation if it will be subjected to freezing temperatures such as routing through unheated areas or through unused chimney.

The combustion air piping must be insulated with 1/2" Armaflex insulation if it is installed above a suspended ceiling or in a warm, humid space such as a laundry room to prevent possible condensation from forming on the outside of the piping.

VENT TERMINAL ASSEMBLY

The combustion air and vent piping must terminate outdoors using the Vent Terminal Assembly Kits.

Two vertical vent terminal kits are available. The 1VK0307 kit is to be used with 1-1/2" and 2" piping, and the 1VK0308 is to be used for 3" piping. Two horizontal vent terminal kits are available. The 1VK0311 kit is to be used with 1-1/2" and 2" piping, and the 1VK0312 is to be used for 3" piping.

NOTE: The 3" vent terminal kit contains one elbow having a "splitter baffle" in one opening. This elbow must be used for the combustion air intake.

Each kit contains the following components:

1. One terminal bracket with 2 - 90 degree PVC elbows.
2. One 90 degree PVC street elbow.
3. One 90 degree PVC elbow.
4. One PVC pipe coupling.
5. Installation instructions.

This terminal kit may be used for rooftop or side wall installation. Rooftop termination is the recommended means, and should be arranged according to one of the methods shown in Figure 6.

NOTE: The vent terminal kit and exposed piping may be painted the same color as the building to make them less noticeable.

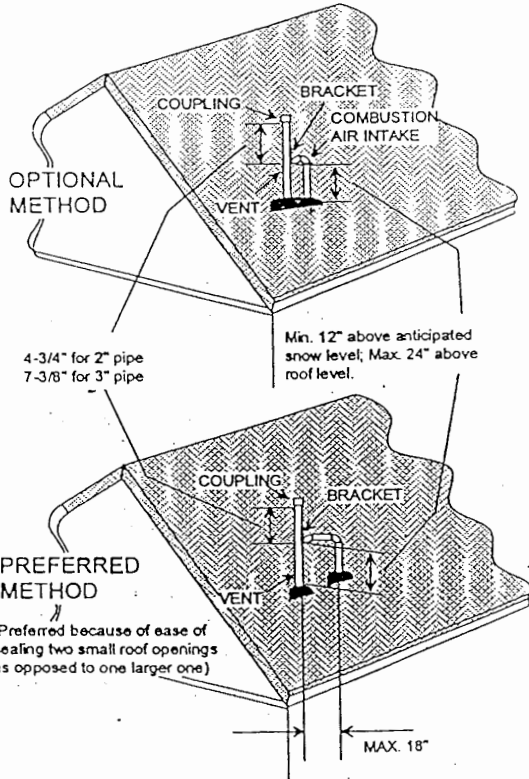
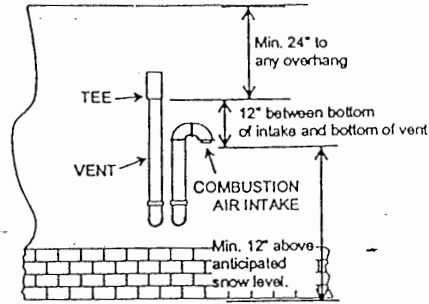

FIGURE 6 - ROOFTOP TERMINATION

If optional side wall venting is to be used, installation of the terminal kit should be as shown in Figures 7 and 8.

The installation procedure for the terminal kit is as follows:

1. Cut all combustion air and vent piping so the vent termination fittings and brackets can be dry-fitted together.



INSTALLATION BELOW ANTICIPATED SNOW LEVEL

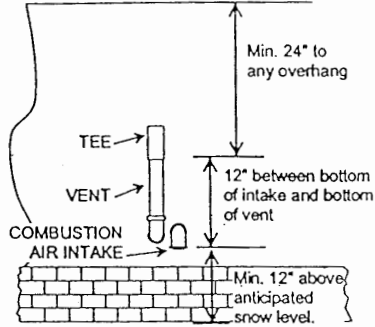

INSTALLATION ABOVE ANTICIPATED SNOW LEVEL
FIGURE 7 - SIDE WALL TERMINATION

2. All piping should be deburred inside and out, and the outside edge should be chamfered.
3. Reassembly all piping and fittings using cement primer and cement per the cement manufacturer's instructions. Primer and cement must conform to ASTM 2564 for PVC or ASTM D2235 for ABS piping.
4. Reattach and tighten the vent termination bracket.

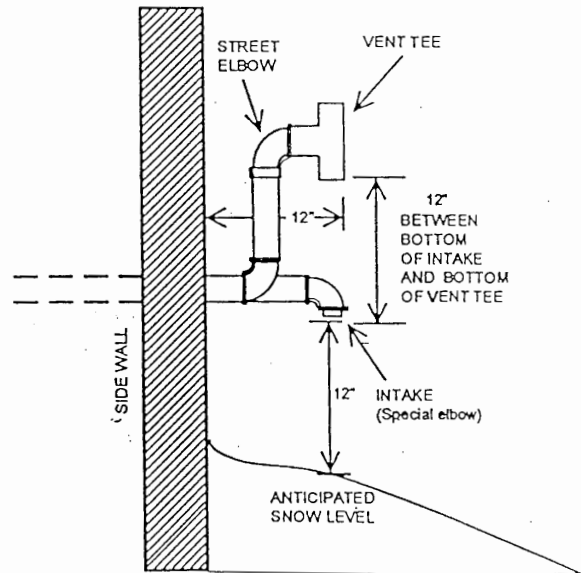

FIGURE 8 - SIDEWALL TERMINATIONS

GAS PIPING

NOTE: An accessible manual shutoff valve must be installed upstream of the furnace gas controls and within 6 feet of the furnace. A 1/8" NPT plugged tapping, accessible for test gauge connection must be installed immediately upstream of the gas supply connection to the furnace.

The furnace and its individual shutoff valve must be disconnected from the gas supply piping system during any pressure testing of that system at test pressures in excess of 1/2 psig (3.48 kPa).

The furnace must be isolated from the gas supply piping system by closing its individual external manual shutoff valve during any pressure testing of the gas supply piping system at pressures equal to or less than 1/2 psig (3.48 kPa).

Gas piping may be connected from either side of the furnace. Sizing and installation of the supply gas line should comply with the local utility requirements. The gas supply should be a separate line, installed in accordance with the National Fuel Gas Code, ANSI Z223.1 or CAN1-B149.1 or .2 Installation Codes (latest editions).

Some utility companies require pipe sizes larger than the maximum sizes listed. Using the properly sized wrought iron, steel or approved flexible pipe, make gas connections to the unit. Installation of a drop leg and ground union joint is required (see Figure 9).

WARNING: Compounds used on threaded joints of gas piping must be resistant to the action of liquified petroleum gases. After connections are made, leak-test all pipe connections.

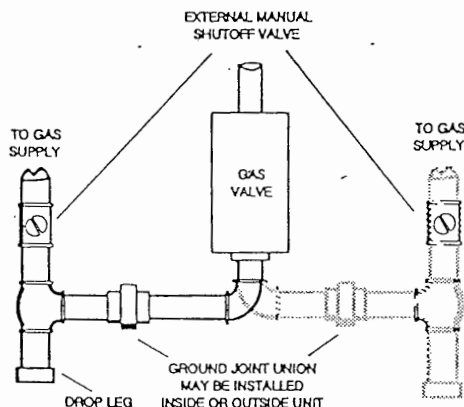

*NOTE: Unit is supplied with a 1/2" "street ell." Where "street ell's" are not allowed, a pipe nipple and elbow may be used. Use of nipple and elbow may require field extending side opening of casing for proper clearance.

FIGURE 9 - GAS PIPING

WARNING: Do not use an open flame or other source of ignition for leak testing. Set the manual gas valve to the OFF position.

INLET GAS PRESSURE		
	Natural Gas	Propane (LP)
Minimum	4.5 In. W.C.	11 In. W.C.
Maximum	10.5 In. W.C.	13.5 In. W.C.

CONDENSATE PIPING

The condensate drain connection assembly is located in the lower right front corner of the blower compartment. It consists of a mounting bracket and 1/2" CPVC coupling (ASTM D2846) with flexible tubing connected to it (see Figure 10). Another knockout is provided above the original location if the added height is necessary. New holes must be drilled for the screws if this alternate location is used.

The installation procedure for condensate piping is as follows:

1. Determine whether the condensate drain line will be installed through the right or left side of the furnace.

2. Carefully remove the 3/4" diameter knockout from the appropriate side of the furnace. Two knockouts are provided on each side, one located toward the lower right front of the blower compartment, the other is located above the first.

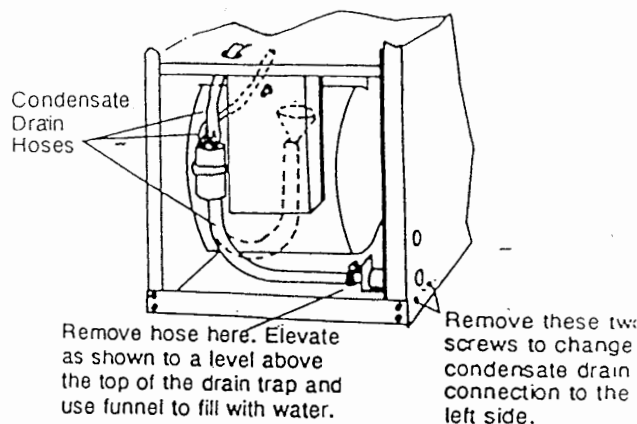

NOTE: Trap is shown exposed but may be behind controls box.

FIGURE 10 - CONDENSATE DRAIN CONNECTION

3. For left side or alternate drain connection, it will be necessary to relocate the condensate drain connection assembly.
 - a. Remove the two screws that secure the drain connection bracket to the right side panel (see Figure 10).
 - b. Position the bracket over the corresponding holes in the left side panel (new holes must be drilled for alternate locations), and fasten it to the side panel using the two screws previously removed.
 - c. Make sure the flexible tubing between the drain trap mounted on the blower and the drain connection assembly has a continuous downward slope to the drain connection assembly, has no low spots, and is not kinked. (If necessary, shorten the flexible tubing to prevent kinking and/or low spots that could restrict the flow of condensate.
4. Connect field-supplied piping to the condensate drain connection assembly and run it to an open drain. Refer to the "Vent/Combustion Air Connections" section of this instruction for procedure for assembly of plastic pipe. The manufacturer recommends 1/2" I.D. CPVC or equivalent field installed drain pipe. The condensate piping may be tied together with the air conditioning condensate drain if the air conditioning condensate drain line is trapped upstream of the tie-in and the combined drains are constructed of the same material.
5. All pipe joints must be cleaned, de-burred and cemented using CPVC primer and cement.
6. The furnace contains an internal trap. Therefore, no external trap should be used.
7. If a condensate pump is used, it must be suitable for use with acidic water.
8. Where required, a field-supplied neutralizer can be installed in the drain line, external to the furnace.

ELECTRICAL DATA

Use copper conductors only!

Field wiring to the unit must conform to and be grounded in accordance with the provisions of the National Electrical Code (NEC), ANSI/NFPA No. 70-1987, Canadian Electrical Code (CEC) CSA C22.1 and/or local codes. Electric wires which are field installed shall conform with the temperature limitation for 63°F/35°C rise above ambient when installed in accordance with instructions. Specific electrical data is given for the furnace on its rating plate and in Table 1 of this instruction.

ELECTRICAL CONNECTIONS

NOTE: The furnace's control system depends on correct polarity of the power supply.

Connect the power supply as shown on the unit wiring label on the inside of the blower compartment door.

Provide a power supply separate from all other circuits. Install overcurrent protection and disconnect switch per local/national electrical codes. The switch should be reasonably close to the unit for convenience in servicing. With the disconnect switch in the OFF position, check all wiring against the unit wiring label. Also, see the wiring diagram in this instruction.

Install the field-supplied thermostat. The thermostat instructions for wiring are packed with the thermostat. With the thermostat in the OFF position and the main electrical source disconnected, complete the low voltage wiring from the thermostat to the terminal board on the low voltage transformer. Typical control wiring is shown in Figure 10A.

Set the heat anticipator in the room thermostat to 1.16 amps. Setting it lower will cause short cycles. Setting it higher will cause the room temperature to exceed the setpoint.

NOTE: Some thermostats do not have adjustable anticipators. On such thermostats, adjust cycle rate to prevent possible short on/off cycles.

The 24-volt transformer is sized for the furnace components only, and should not be connected to auxiliary devices such as humidifiers, air cleaners, etc.

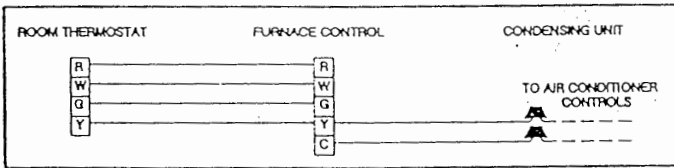

FIGURE 10A - TYPICAL CONTROL WIRING

SAFETY CONTROLS

Interlock Switch

This unit is equipped with an Electrical Interlock Switch mounted in the blower compartment. This switch interrupts power at the unit when the panel covering the blower compartment is removed. This prevents operation of the automatic gas control valve and the blower.

WARNING: Blower and burner must never be operated without the blower panel in place.

Electrical supply to this unit is dependent upon the panel that covers the blower compartment being in place and properly positioned.

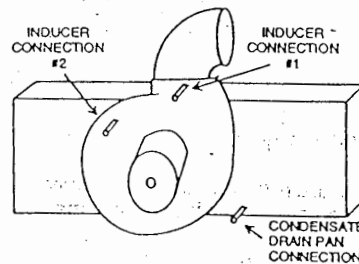
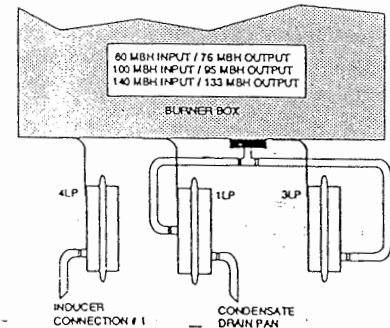
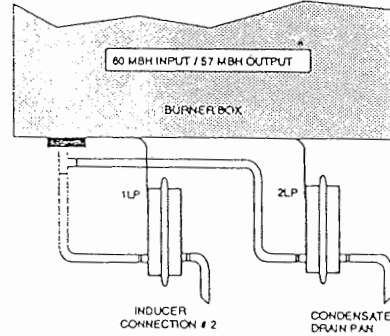
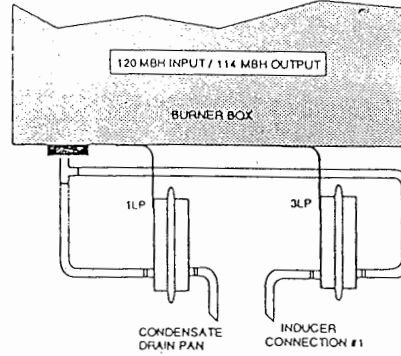
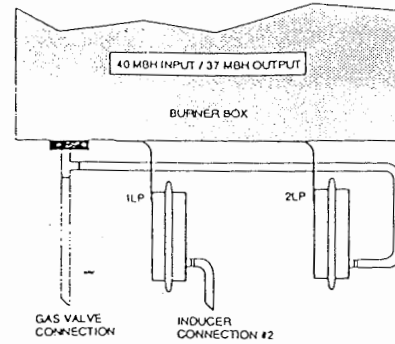

FIGURE 11 - PRESSURE SWITCH TUBING ROUTING

CAUTION: Main power to the unit must still be interrupted at the main power disconnect switch before any service or repair work is to be done to the unit. Do not rely upon the interlock switch as a main power disconnect.

Fusible Link Control

This control is mounted in the burner compartment. If the temperature in the burner compartment exceeds 306°F, the circuit to the igniter control and the gas valve is de-energized. This is a one-time fusible link type control. Before the furnace can operate again, the control must be replaced. The operation of this control indicates a possible burner flame rollout condition. The combustion air blower and the combustion air pressure switch should be checked for proper operation.

Pressure Switches

This furnace is supplied with pressure switches which monitor the flow through the combustion air/vent piping system. These switches de-energize the ignition control module and the gas valve if any of the following conditions are present.

1. Blockage of combustion air piping or terminal.
2. Blockage of vent piping or terminal.
3. Failure of combustion air blower motor.
4. Blockage of condensate drain piping.

START-UP AND ADJUSTMENTS

The initial start-up of the furnace requires the following additional procedures:

1. When the gas supply is initially connected to the furnace, the gas piping may be full of air. In order to purge this air, it is recommended that the ground union be loosened until the odor of gas is detected. When gas is detected, immediately retighten the union and check for leaks. Allow five minutes for any gas to dissipate before continuing with the start-up procedure.

WARNING: Be sure proper ventilation is available to dilute and carry away any vented gas.

2. The condensate trap must be filled with water before putting the furnace into operation. The recommended procedure is as follows:
 - a. Disconnect the condensate drain hose from the condensate drain outlet fitting (see Figure 10 for location of this hose connection).
 - b. Elevate this hose above trap level and fill with water using a funnel. Drain excess water into a container.
 - c. Replace the condensate drain hose and clamps.
3. All electrical connections made in the field and in the factory should be checked for proper tightness.

IGNITION SYSTEM CHECKOUT/ADJUSTMENT

1. Turn gas supply OFF at external gas valve or main gas valve (see Figure 12). Turn electrical power ON. Check that 24 volts is available across terminal C and R on the transformer.
2. Check ignition module operation as follows:
 - a. Set the thermostat to "heat". Turn thermostat setting above room temperature to call for heat.
 - b. Through burner box observation ports watch for the hot surface igniter to begin glowing.
 - c. If glow is seen, turn the thermostat down (below room temperature). Hot surface igniter should stop glowing.
3. Turn the gas supply ON at external valve and main gas valve.
4. Set the thermostat above room temperature to call for heat.
5. System start-up will occur as follows:

- a. Venter motor will start and come up to speed. Shortly after venter start-up, the hot surface igniter will glow for about 45 seconds.
- b. After warm-up cycle, ignition module will energize (open) the main gas valve for four seconds. At the same time power to the igniter is shut off.

NOTE: Burner ignition may not be satisfactory on first start-up due to residual air in gas line, or until gas pressure (manifold) or burner air shutters are adjusted.

6. With furnace in operation, paint the pipe joints and valve gasket lines with a rich soap and water solution. Bubble indicate a gas leak. Take appropriate steps to stop the leaks. If the leak persists, replace the component.

WARNING: DO NOT omit this test! NEVER use a flame to check for gas leaks.

ADJUSTMENT OF MANIFOLD GAS PRESSURE

1. Turn gas off at main gas valve. Remove 1/8" plug in the main gas valve body and install proper manometer tube adapter fitting. Connect line from gas valve tap to manometer.
2. Refer to Figure 12 for location of pressure regulator adjustment cap and screw on main gas valve.

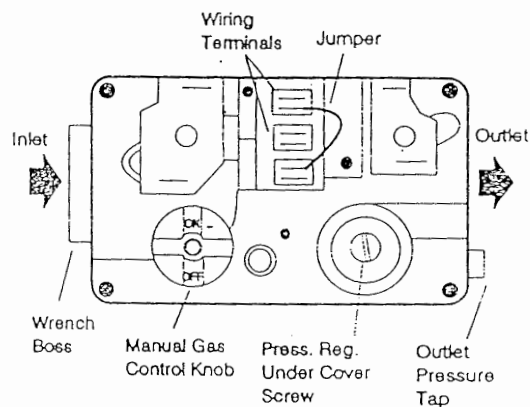

FIGURE 12 - GAS VALVE

NOTE: The screw-off cap for the pressure regulator must be removed entirely to gain access to the adjustment screw. Loosening or tightening the cap does not adjust the flow of gas.

3. Turn gas and electrical supplies ON. Start furnace and observe manifold pressure on manometer.
4. Adjust manifold pressure by adjusting gas valve regulator screw: for natural gas, set at 3.5" W.C.; for propane (LP) gas, set at 10.0" W.C.

If gas valve regulator is turned in, or clockwise, manifold pressure is increased. If screw is turned out, or counter-clockwise, manifold pressure will decrease.

Natural Gas	3.5" W.C.
Propane (LP)	10.0" W.C.

WARNING: If manifold pressure is too high, an over-fire condition exists which could cause heat exchanger failure. If the manifold pressure is too low, sooting and eventual clogging of the heat exchanger could occur.

WARNING: Once the correct gas pressure to the burners has been established, turn the gas valve knob to OFF and turn the electrical supply switch to OFF; then remove the pressure tap at the gas valve and re-install the plug, using a compound (on the threads) resistant to the action of LP gases.

Turn the electrical and gas supplies back on, and with the burners in operation, check for gas leakage around the plug with a soap and water solution.

ADJUSTMENT OF PRIMARY AIR

The main burners should be in operation for 15 minutes before making the primary air adjustment. The burner flame should not contain any yellow color (Refer to Figure 13). With the furnace operating at full input, adjust the primary air of the burners as follows:

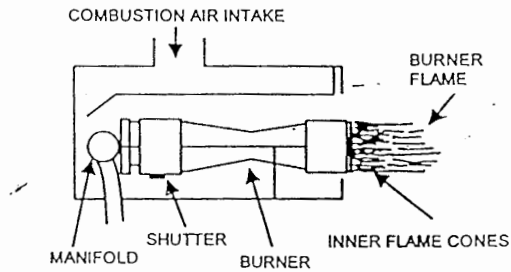

FIGURE 13 - PROPER FLAME APPEARANCE

CAUTION: The front panel of the burner enclosure must be in place and secured with screws during normal operation and when observing the proper burner flame.

Natural Gas or Propane (LP)

All models are shipped with the air shutters wide open. Local variations in the gas supply may require changes in the settings described above. To change the air shutter settings, use the following procedure:

1. Remove the front access door.
2. Turn off all power to the unit and remove the front door of the burner box.
3. Rotate the burners until the air shutter locking screw is facing downward.
4. Adjust the air shutters with the power to the unit "OFF" and retighten the locking screws.
5. Re-install the front door of the burner box and tighten the screws which secure the door.
6. Restore power and start the unit. Observe through the observation port to see if all flames are now blue in color. If yellow flames are still visible, repeat steps 2 thru 6.
7. Cycle the burners on an off a few times to verify the burners are lighting promptly and properly
8. Replace front access door.

CHECKING GAS INPUT (NATURAL GAS)

NOTE: Front door of burner box must be secured when checking gas input.

1. Turn off all other gas appliances connected to the gas meter.
2. With the furnace turned on, measure the time needed for one revolution of the hand on the smallest dial on the meter. A typical domestic gas meter usually has a 1/2 or 1 cubic foot test dial.
3. Using the number of seconds for each revolution and the size of the test dial increment, find the cubic feet of gas

TABLE 3 - GAS RATE (CUBIC FEET PER HOUR)

Seconds for one Revol.	Size of Test Dial	
	1/2 cu. ft.	1 cu. ft.
10	180	360
12	150	300
14	129	257
16	113	225
18	100	200
20	90	180
22	82	164
24	75	150
26	69	138
28	64	129
30	60	120
32	56	113
34	53	106
36	50	100
38	47	95
40	45	90
42	43	86
44	41	82
46	39	78
48	37	75
50	36	72
52	35	69
54	34	67
56	32	64
58	31	62
60	30	60

NOTE: To find the Btuh input, multiply the number of cubic feet of gas consumed per hour by the BTU content of the gas in your particular locality. Contact your gas company for this information, as it varies widely from city to city.

EXAMPLE: It is found by measurement that it takes 26 seconds for the hand on the 1 cubic foot dial to make a revolution with only a 120,000 Btuh furnace running. Using this information, locate 26 seconds in the first column of Table 3. Read across to the column headed "1 cubic foot" where you will see that 138 cubic feet of gas per hour are consumed by the furnace at that rate. Multiply 138 by 850 (the BTU rating of the gas obtained from the local gas company). The result is 117,300 Btuh, which is close to the 120,000 Btuh rating of the furnace.

If the actual input is not within 5% of the furnace rating, with allowance being made for the permissible range of the regulator setting (0.3 inches W.C.), replace the orifice spuds with spuds of the proper size.

CAUTION: Be sure to relight any gas appliances that were turned off at the start of this input check.

ADJUSTMENT OF TEMPERATURE RISE

The temperature rise, or temperature difference between the return air and the heated air from the furnace, must be within the range shown on the furnace rating plate and within the application limitations shown in Table 1. After the temperature rise has been determined, the cfm can be calculated.

After about 20 minutes of operation, determine the furnace temperature rise. Take readings of both the return air and the heated air in the ducts, about six feet from the furnace where

they will not be affected by radiant heat. Increase the blower speed to decrease the temperature rise; decrease the blower speed to increase the rise.

All direct-drive blowers have multi-speed blowers. Refer to the unit wiring diagram and connect the blower motor for the desired speed. The blower motor speed taps are located in the control box in the blower compartment.

ADJUSTMENT OF FAN CONTROL SETTINGS

NOTE: Fan-On time is preset and not adjustable. When the main gas valve is energized (ON), two wires carry 24v to a small heater which controls fan-on timing.

To adjust the Fan Off setting:

1. Turn the furnace on.
2. Let the furnace operate for 20 minutes.
3. Turn the furnace off.
4. Read the thermometer when the blower stops.
5. If this temperature is too high when the blower stops, lower the fan off setting; if the temperature is too low, raise the setting.
6. If adjustments are made to the fan off setting, check the operation of the furnace by repeating the previous steps.

CAUTION: When fan on and fan off adjustments are made, be careful not to rotate the fan control dial. If the dial is allowed to rotate, the control could be damaged and operate erratically.

CHECKING LIMIT CONTROL

With the main burners operating, cover all return air grilles with paper to restrict the flow of return air. In a few minutes, the burners should be shut off by the limit control. Remove the return air restrictions. The main blower will cool the unit. The limit switch should reclose and main burners relight after the proper re-start period.

OPERATION & MAINTENANCE

SEQUENCE OF OPERATION

Hot Surface Ignition System

WARNING: Do not attempt to light this furnace by hand (with a match or any other means). There may be a potential shock hazard from the components of the hot surface ignition system. The furnace can only be lit automatically by its hot surface ignition system.

The following describes the sequence of operation of the furnace. Refer to the schematic wiring diagram (pages 16 and 17) for component location.

Continuous Blower

On the cooling/heating units with fan switch, when the fan switch is set in the ON position, a circuit is completed between terminals R and G of the thermostat. This energizes the 1R relay. Contact 1R-1 closes and contact 1R-2 opens. The motor is energized through the black, high-speed tap. The blower then operates on high speed.

Intermittent Blower

When the system switch is set on HEAT and the fan switch is set on AUTO, and the room thermostat calls for heat, a circuit is completed between terminals R and W of the thermostat. This energizes the venter relay 3R, which energizes the venter. When the proper amount of combustion air is being provided, a pressure switch activates the 50E47 ignition control. A second and third pressure switch (2LP or 3LP and 4LP)(not used in all models), the fusible link (FL) and the limit are in this circuit, and must be in the closed position for the ignition control to be activated.

The 50E47 ignition control provides a 45-second warm-up period. The gas valve then opens for four seconds.

As gas starts to flow and ignition occurs, the flame sensor begins its sensing function. If a flame is detected within four seconds after ignition, normal furnace operation continues until the thermostat circuit between R and W is opened. When the supply air temperature reaches 115 to 125°F, the fan switch closes.

When the thermostat circuit opens, the venter is deenergized, along with the ignition control. With the ignition control deenergized, the gas flow stops and the burner flames are extinguished.

The blower motor continues to operate until the supply air temperature drops to between 85 and 100°F. When this occurs, the fan switch opens, de-energizing the blower motor. The heating cycle is then complete, and the unit is ready for the start of the next heating cycle.

If flame is not detected within the four second sensing period, the gas valve is de-energized. The 50E47 control is equipped with a re-try option. This provides a 60-second wait following an unsuccessful ignition attempt (flame not detected). After the 60 second wait, the ignition sequence is restarted with an additional 10 seconds of igniter warm-up time. If this ignition attempt is unsuccessful, one more re-try will be made before lockout.

50E47 HOT SURFACE IGNITION CONTROL

All 50E47 controls will repeat the ignition sequence for a total of five recycles if flame is lost within the first 10 seconds of establishment.

If flame is established for more than 10 seconds after ignition, the controller will clear the ignition attempt (re-try) counter. If flame is lost after 10 seconds, it will restart the ignition sequence. This can occur a maximum of five times.

During burner operation, a momentary loss of power of 50 milliseconds or longer will drop out the main gas valve. When the power is restored, the gas valve will remain de-energized, and a restart of the ignition sequence will begin immediately.

A momentary loss of gas supply, flame blowout, or a shorted or open condition in the flame probe circuit will be sensed within 0.8 seconds. The gas valve will de-energize and the control will restart the ignition sequence after waiting 60 seconds. Recycles will begin and the burner will operate normally if the gas supply returns, or the fault condition is corrected prior to the last ignition attempt. Otherwise, the control will lockout.

If the control is locked out, it may be reset by momentary power interruption of 1/20 second or longer. Either the 24v thermostat or line voltage may be interrupted.

MAINTENANCE

The manufacturer recommends that maintenance is performed by a qualified service agency for cleaning vent/air intakes, condensate drains and neutralizers, burners, primary and secondary heat exchangers and the blower motor and wheel assembly. Examine the condensate collection tubing for any kinks or blockage. An annual inspection of these components is recommended.

Air Filters

The filters should be checked periodically for dirt accumulation. Dirty filters greatly restrict the flow of air and overburden the system.

Clean the filters at least every three months. See page 4 for filter removal instructions. On new construction, check the filters every week for the first four weeks. Inspect the filters at least every three weeks after that, especially if the system is running constantly.

Air filters supplied with the furnace are the high-velocity, cleanable type. Clean these filters by washing in warm water. Make sure to shake all the water out of the filter and have it reasonable dry before installing it in the furnace. When replacing filters, be sure to use the same size and type as originally supplied.

Lubrication

Blower motors in these furnaces are permanently lubricated and do not require periodic oiling.

Burner Removal/Cleaning

The main burners should be checked periodically for dirt accumulation.

If cleaning is required, follow the steps listed below:

1. Turn off the electrical power to the unit.
2. Remove the upper access door.
3. Remove the front cover of the burner box.
4. Remove burners by applying pressure to burner retention spring until burner can be removed from the hole in burner support plate.
5. Slide burner down and off the orifice, leaving the retention spring in place.
6. Burners may be cleaned by rinsing in hot water.
7. Reassemble the burners in the reverse order.

Cleaning the Primary Heat Exchanger

1. Turn off the main manual gas valve external to the furnace.
2. Turn off the electrical power to the furnace.
3. Remove the access door.

4. Disconnect the gas supply piping and control wiring from the gas valve.
5. Remove the screws holding the burner box assembly to the vestibule panel.
6. Remove the burner box assembly.
7. Remove the burner restrictor plate to gain access to the upper portion of the heat exchanger.
8. To reach the lower portion of the heat exchanger, remove the flue box cover and flue baffles.
9. With a stiff wire brush, brush out loose scale or soot.
10. Vacuum the burner assembly and heat exchanger.
11. Replace all parts removed for cleaning by reversing the order of disassembly.
12. Reconnect all wiring and gas piping.
13. Restore electrical power and gas supply to the furnace.

Cleaning the Secondary Heat Exchanger

1. Follow steps 1 thru 10 under "Cleaning the Primary Heat Exchanger."
2. Remove the vent piping from the venter housing. Disconnect the drain lines from the venter and from the condensate drain pan. Remove the venter blower and the condensate pan. The turbulators can then be gently removed from the secondary heat exchanger.
3. With a stiff wire brush, brush out loose scale or soot.
4. Vacuum the secondary heat exchanger.
5. Finish the cleaning procedure by following steps 11 thru 13 under "Cleaning the Primary Heat Exchanger."

VENT/AIR INTAKE

Should it be necessary to service the vent/air intake system, the manufacturer recommends this service be conducted by a qualified service agency.

The instructions on Page 7 of this instruction specify cementing all joints except the junction at the inducer blower housing. This joint is to sealed with RTV.

The operation of this appliance requires the reassembly and resealing of the vent/air intake system as specified on Page 7.

BLOWER CARE

Even with good filters properly in place, blower wheels and motors will become dust laden after long months of operation. The entire blower assembly should be inspected annually. If the motor and wheel are heavily coated with dust, they can be brushed and cleaned with a vacuum cleaner.

The procedure for removing the blower assembly for cleaning is as follows:

1. Disconnect the electrical supply to the furnace.

2. Remove the access panels.
3. Disconnect the two wire harness plugs from the top of the control box.
4. Remove the four screws holding the control box and position it out of the way.
5. Remove the hoses from the top of the condensate drain trap, and one at the front of the trap.
6. Remove screws which retain blower to the blower deck.
7. Remove the blower assembly with the condensate drain trap and the control wiring still attached.
8. Vacuum the motor and the blower wheel using a soft brush attachment. Care must be used not to disturb the balance weights (clips) on the blower wheel vanes.
9. Before reinstalling the blower assembly, inspect the lower portion of the secondary heat exchanger which is visible directly above the blower opening in the blower deck. If it requires cleaning, vacuum it with a soft brush attachment and follow the direction of the fins.
10. Reinstall the blower assembly and the condensate drain hoses. Replace the mounting screws that hold the blower assembly to the front portion of the blower deck. The two mounting screws used on the sides of the blower are used for shipping purposes only, and are not necessary after the furnace has been installed.
11. Reinstall the control box and reconnect the wiring harness plugs.
12. Replace the access doors and restore the electrical supply to the unit.

WARNING: If the condensate drain trap has been emptied during this cleaning procedure, refill it by following the instructions found in the "Start-Up and Adjustment" section on this instruction.

13. Operate the unit for a minimum of five minutes and carefully check for any leaks in the condensate drain connections.

TROUBLESHOOTING

CAUTION: Label all wires prior to disconnection when servicing controls. Wiring errors can cause improper and dangerous operation. Verify proper operation after servicing.

The following visual checks should be made before troubleshooting:

1. Check to see that the power to the furnace and the 50E47 control module is ON.
2. The manual shutoff valves in the gas line to the furnace must be open.
3. Make sure all wiring connections are secure.
4. Review the sequence of operation.

Start the system by setting the thermostat above the room temperature. Observe the system's response. Then use the Troubleshooting Table to check the system's operation.

Start the system by reading the upper left-hand box and then following the instructions in each box. If the condition described in the box is true (yes answer), go down to the next box. If the condition is not true (no answer), go to the box to the right. Continue checking and answering the questions in the boxes until the problem is explained and corrective action is described. After any maintenance or repair, the troubleshooting sequence should be repeated until normal system operation is obtained.

WARNING: Do not try to repair controls. Replace defective controls with UPG Source 1 Parts.

WIRING DIAGRAM - 37 thru 56 MBH OUTPUT

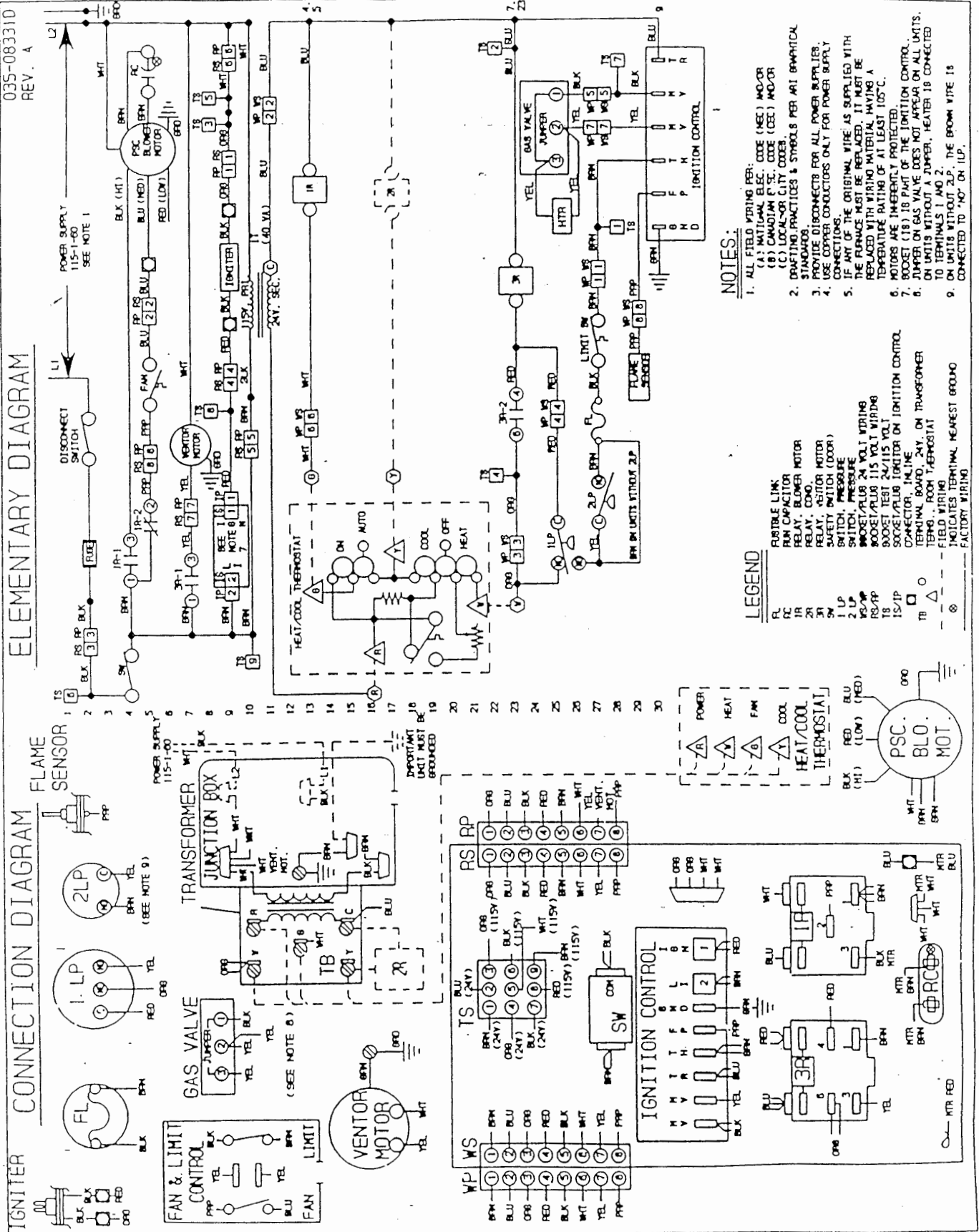

WIRING DIAGRAM - 75 thru 131 MBH OUTPUT

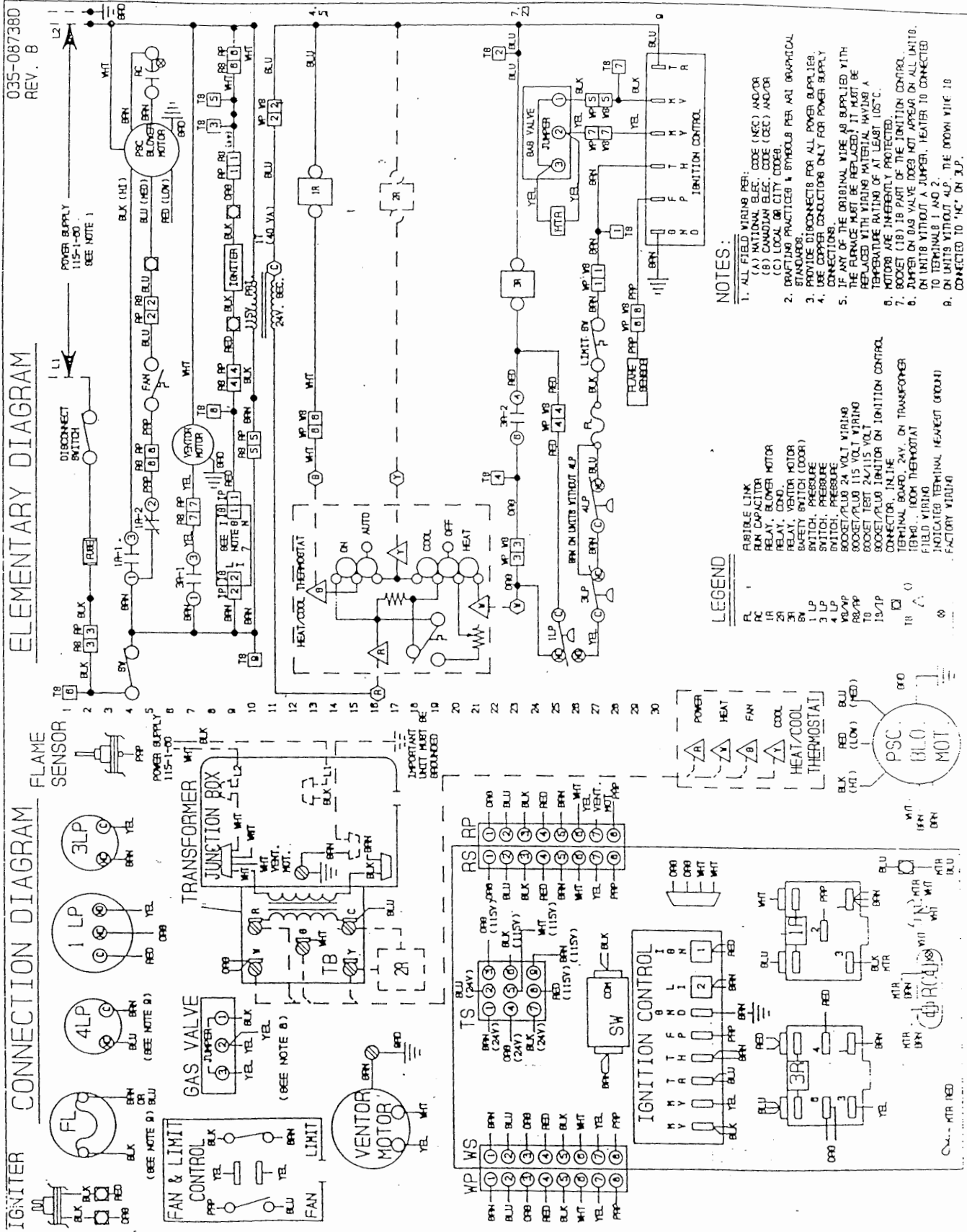

035-087380
REV. B

ELEMENTARY DIAGRAM

CONNECTION DIAGRAM

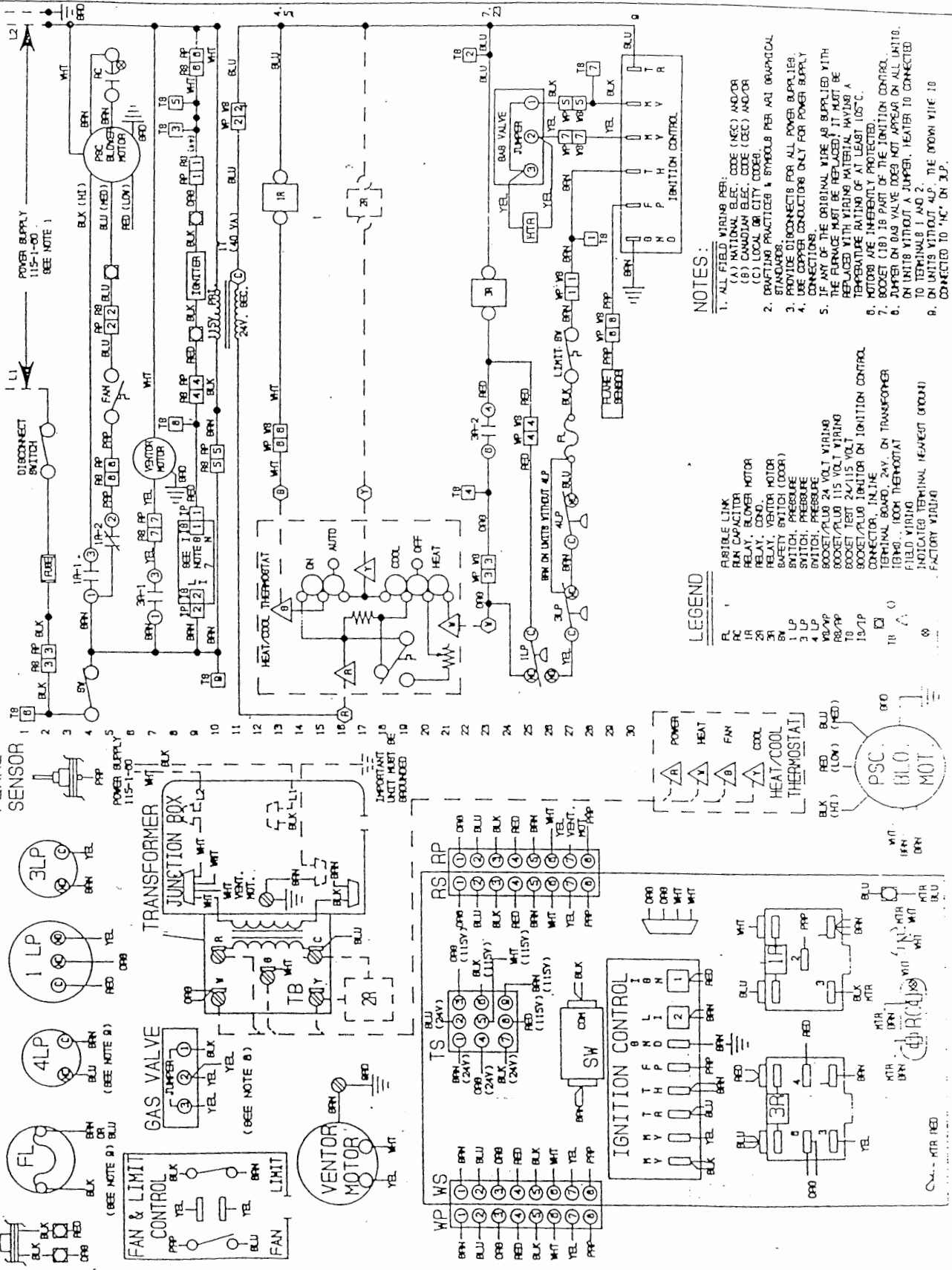

NOTES

- ALL FIELD WIRING PER: (A) NATIONAL BLEC. CODE (NCC) AND/OR (B) CANADIAN BLEC. CODE (CBC) AND/OR (C) LOCAL OR CITY CODES.
- STANDARDS.
- PROVIDE DISCONNECTS FOR ALL POWER SUPPLIES.
- USE COPPER CONDUCTORS ONLY FOR POWER SUPPLY CONNECTIONS.
- IF ANY OF THE ORIGINAL WIRE IS SUPPLIED WITH THE FURNACE MUST BE REPLACED, IT MUST BE REPLACED WITH WIRING MATERIAL HAVING A TEMPERATURE RATING OF AT LEAST 105°C.
- MOTORS ARE INHERENTLY PROTECTED.
- BOCKET (18) IS PART OF THE IGNITION CONTROL ON UNITS WITHOUT A JUMPER, HEATER TO TERMINALS 1 AND 2.
- ON UNITS WITHOUT 4LP, THE 000W WIRE IS CONNECTED TO "C" ON 3LP.

LEGEND

- | | |
|-----|---------------------|
| FL | FLAME LINK |
| RC | RELAY CAPACITOR |
| IR | RELAY, BLOWER MOTOR |
| 2R | RELAY, COOL |
| 3R | RELAY, HEAT |
| 5R | RELAY, MOTOR (ROOM) |
| 6R | RELAY, PRESSURE |
| 7R | RELAY, PRESSURE |
| 8R | RELAY, PRESSURE |
| 9R | RELAY, PRESSURE |
| 10R | RELAY, PRESSURE |
| 11R | RELAY, PRESSURE |
| 12R | RELAY, PRESSURE |
| 13R | RELAY, PRESSURE |
| 14R | RELAY, PRESSURE |
| 15R | RELAY, PRESSURE |
| 16R | RELAY, PRESSURE |
| 17R | RELAY, PRESSURE |
| 18R | RELAY, PRESSURE |
| 19R | RELAY, PRESSURE |
| 20R | RELAY, PRESSURE |
| 21R | RELAY, PRESSURE |
| 22R | RELAY, PRESSURE |
| 23R | RELAY, PRESSURE |
| 24R | RELAY, PRESSURE |
| 25R | RELAY, PRESSURE |
| 26R | RELAY, PRESSURE |
| 27R | RELAY, PRESSURE |
| 28R | RELAY, PRESSURE |
| 29R | RELAY, PRESSURE |
| 30R | RELAY, PRESSURE |

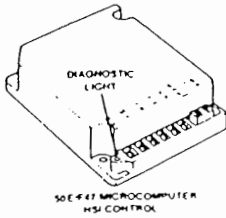

NOTE: Models with diagnostic light have self-diagnostic capabilities. If the light on the module is on continuously, the fault is likely to be internal to the module. To make sure, interrupt the line or 25 volt thermostat power for a few seconds and then restore power. If internal fault is indicated again, and flame sensor is not shorted to ground, replace control. A flashing light also indicates the problem is most likely in the external components or wiring. Proceed following the troubleshooting table below. If 120 vac power wiring to furnace is reversed, module will lockout.

WHITE-RODGERS 50E47 SYSTEM TROUBLESHOOTING TABLE

NOTE: Before troubleshooting, familiarize yourself with the startup and checkout procedures.

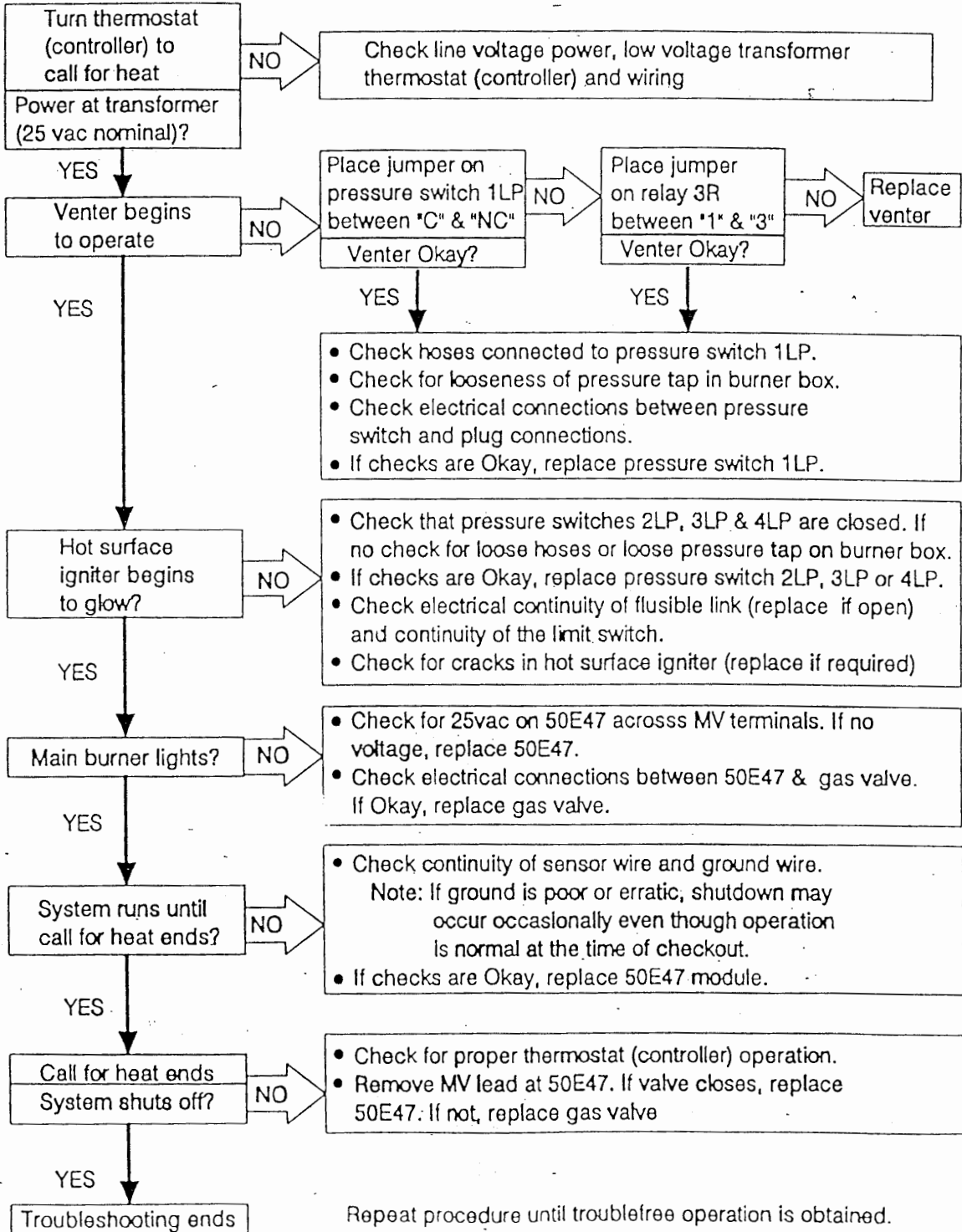

Repeat procedure until troublefree operation is obtained.